





```

      SooS
    /-----S\S
   / |         |
  * ||-----||
   ^^         ^^

```

Cette vache a appartenu  
a George Washington

```

      (oo)  \
    /-----\ /
   / |         |
  * ||-----||
   ^^         ^^

```

Benjamin Franklin  
a possede cette vache

```

      (oo)
    /-----\
   / |         |
  * ||-----||
   ^^         ^^

```

Vache d''Abe Lincoln

```

      ( )
      (oo)
     \-----\
    / |         |
   * ||-----||
     ^^         ^^

```

Vieux "bandit manchot"  
du Ceasar Palace

```

      ( )
      (oo)
     /-----\
    / | | / | |
   * ||-----||
     ^^         ^^

```

Cette vache a ete donnee a  
Hugh Hefner (play boy) pour son anniversaire

```

      ( )
      ( O )
     /-----\
    / |         |
   * ||-----||
     ^^         ^^

```

La vache du cyclope que Jason et  
les argonautes ont rencontre

```

      ( )      ( )
      (oo)     (oo)
     \-----\
    / |         |
   * ||-----||
     ^^         ^^

```

Cette vache vivait avec le  
Dr. Doolittle

```

      ( )
      [##]
     /-----\
    / |         |
   * ||-----||
     ^^         ^^

```

Cette vache a appartenu  
a Flash Gordon

```

      ( )
      (@o)
     /-----\
    / |         |
   * ||-----||
     ^^         ^^

```

Cette vache vivait  
avec des petits voyous

```

      ( )
     /----- ( )
    / |         | (oo)
   * ||-----\
     ^^         ^

```

Cette vache appartenait  
au cavalier sans tete

The following three cows were supposed to be appearing with the  
celebrity cows pictured above... However, I found out that they  
were sitting around a bar getting drunk discussing what exactly  
is art. The cows' conclusion: Art is a bunch of bull(s).

Sorry, but I couldn't resist.  
Hawk, Sesquipedalianite  
and head of Heifer Control.

```

      ( )
      (oo)
     /-----\
    / |         |
   * ||-----||
     /\ / \   /\ / \

```

Cette vache appartenait  
a Pablo Picasso  
Escher

```

      ( )
      (o o)
     /-----\ /-----
    / |         | \
   * ||-----||
     /\ / \   /\ / \

```

C''etait la vache favorite  
de Salvatore Dali

```

      ( )
      ( o o )
     /-----\
    / |         |
   * ||-----||
     ^^^^     ^^^^

```

Personne ne sait si  
la vache de M.C.

huit

possede quatre ou

jambes





```

          *
        **  **
      * ** * * **
    * / / \ * *
  \ \ / \ \ / /
 * / / \ \ ( ) \ \
  / / \ \ (00) / /
 \ / /-----\ / \ \
  / / | | | | \ / \ \
 \ \ * | |-----| | \ \
 / / ^ ^ ^ ^ / /

```

Vache en chaleur

```

          ( )
        /----- (00)
      / | | | | ( )
 * | |----- | | ( )
   | | | | | |
   ^ ^ ^ ^

```

Vache machant du chewing gum

From: Anonymous (name withheld upon request)

```

          ( )
        (o o)
      /-----\ / ( )
    / | | | | (oo)
  | / /-----\-----\ /
 / \ oo=== | / | |
 | | | * | | ~-----| |
 * ~ ~ ~ ~ ~

```

"D'ou sort cette camera!"

```

          ( )
        (oo)
      /-----\ /
    / | | | |
 * | |-----| |
   oo oo
Vache de Detroit

```

```

          \ \
          (oo)
        /-----\ /
    / | | | |
 * | |-----| |
   oo oo
Vache mustang

```

```

          ( )
        (oo)
      *+-----\ /
    | |-----| |
     | |-----| |
     oo oo
Vache Pick-up

```



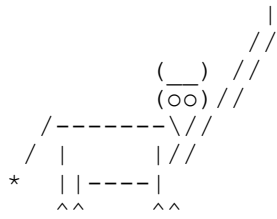

Vache Julie Andrews

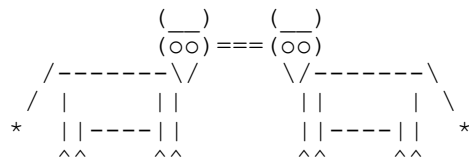

Vaches siamoises

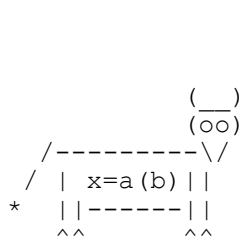

Vache  
Mathematicienne

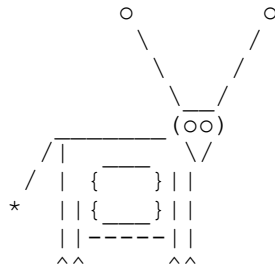

Vache  
Television

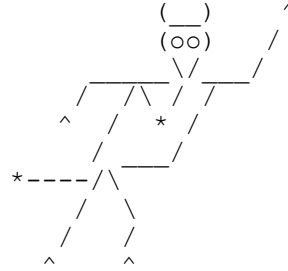

Ceci est la vache disco  
(cow Disco) dans le texte.  
(Cela vient de la contraction de cow-

caine)

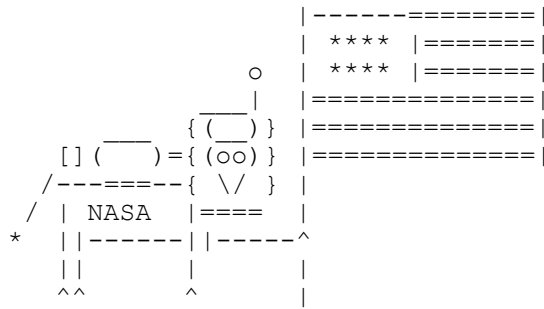
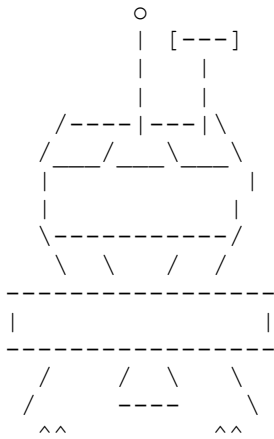

Cette vache a marche sur la Lune

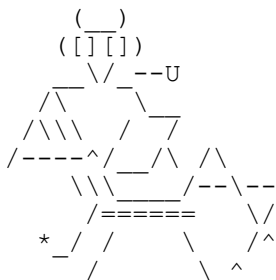

Psycholovache et son patient

"J'ai toujours ce r^ve r^current sur  
les arches d'or."..

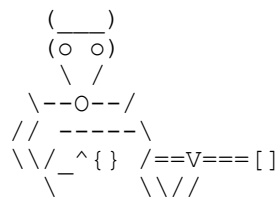
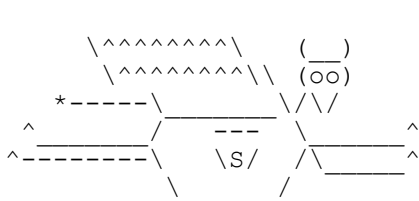
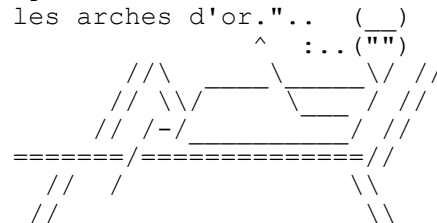

C'est un oiseau...  
 C'est un avion...  
 Non, c'est Supervache



The Boss

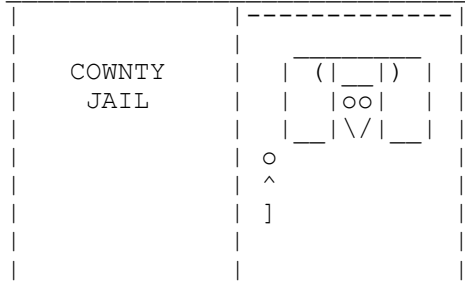

Vache en prison...

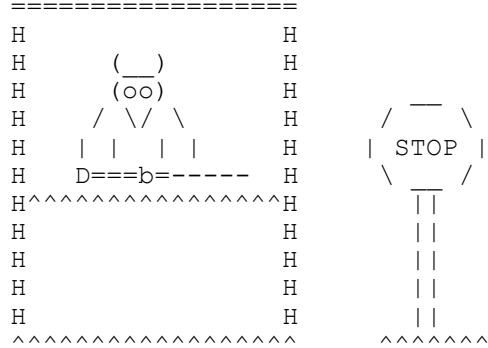

Gardienne du troupeau

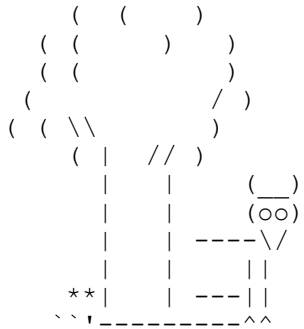

Cache-Vache

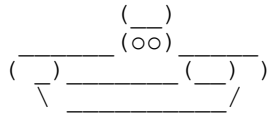

Tarte a la vache

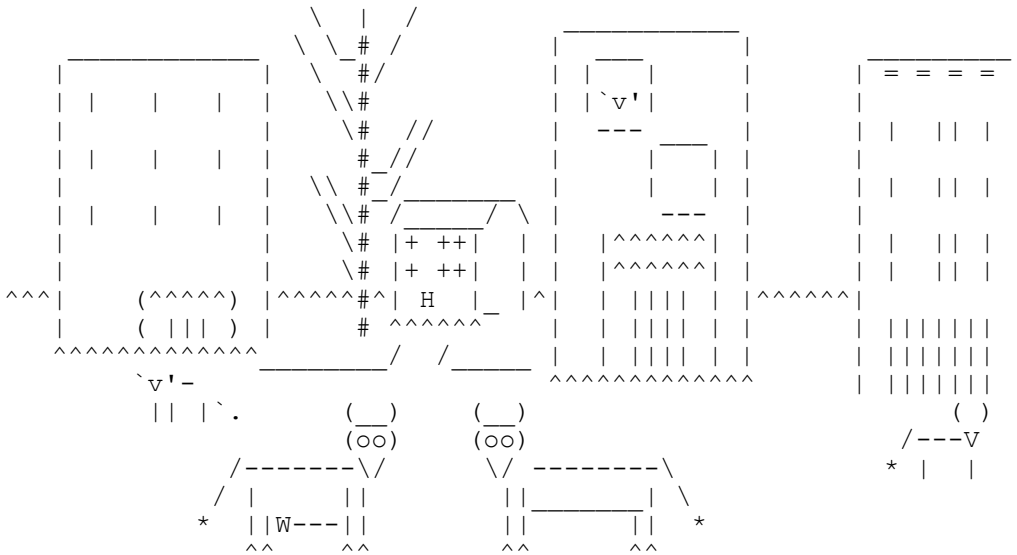

"Cow Town"













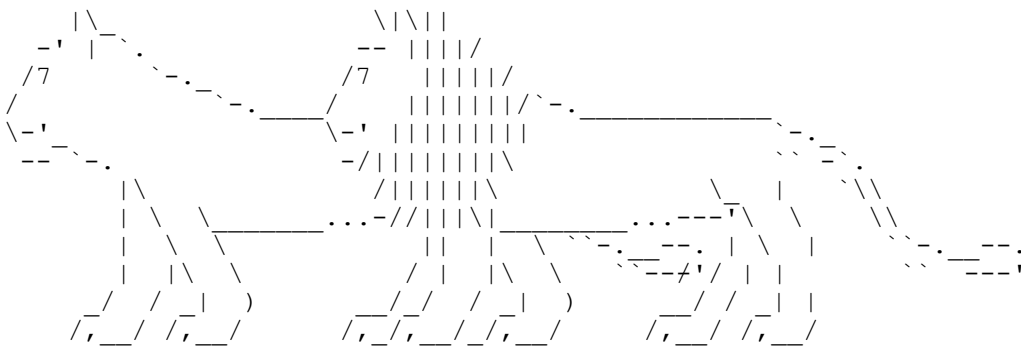
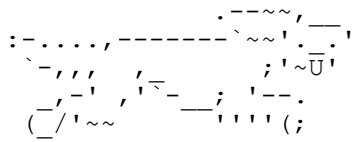
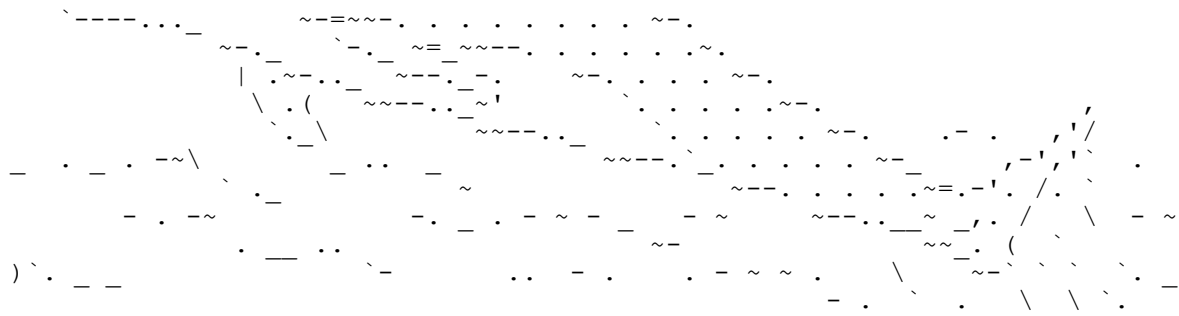

(o o) (o o)  
( v ) ( v )  
/--m-m- /--m-m-

| \\_\_\_\_\_/ |  
|[o] [o] | Jean  
| v | Pajerek  
-ooo---ooo-

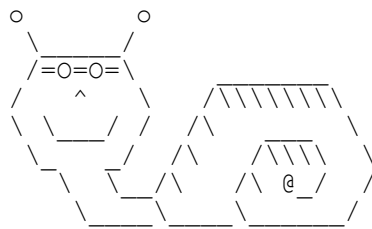
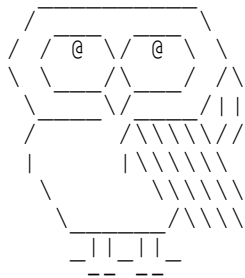









ASCII art of a long horizontal shape with wavy lines and dashes.  
-jury-

ASCII art of a circular shape with a dashed outline and a dotted interior.

ASCII art of a rectangular shape with a dashed outline and internal lines.

ASCII art of a complex shape with a dashed outline, containing the text "mm" and a block of asterisks.

ASCII art of a rectangular shape with a dashed outline and internal lines.

ASCII art of a circular shape with a dashed outline and internal lines, containing the text "Oo" and "OOo".

"--"

|\_ |\_ |\_ |

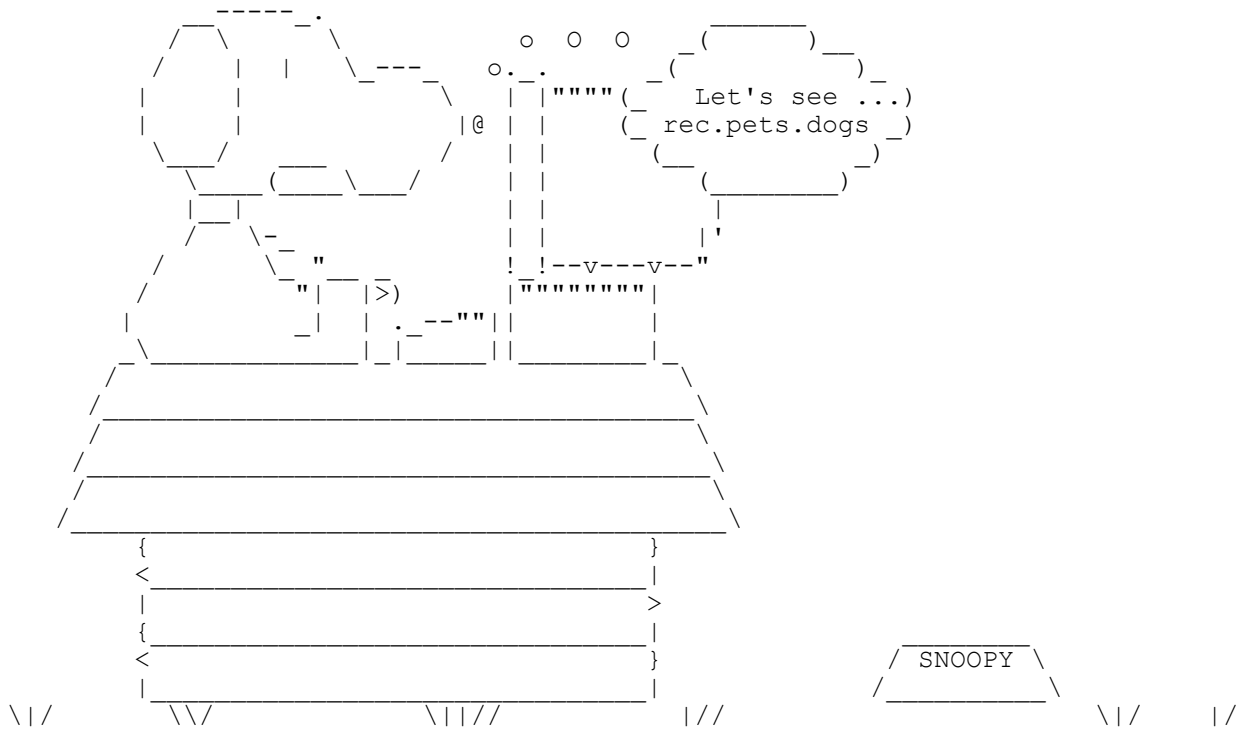

Snoopy peanuts cartoon playing tennis

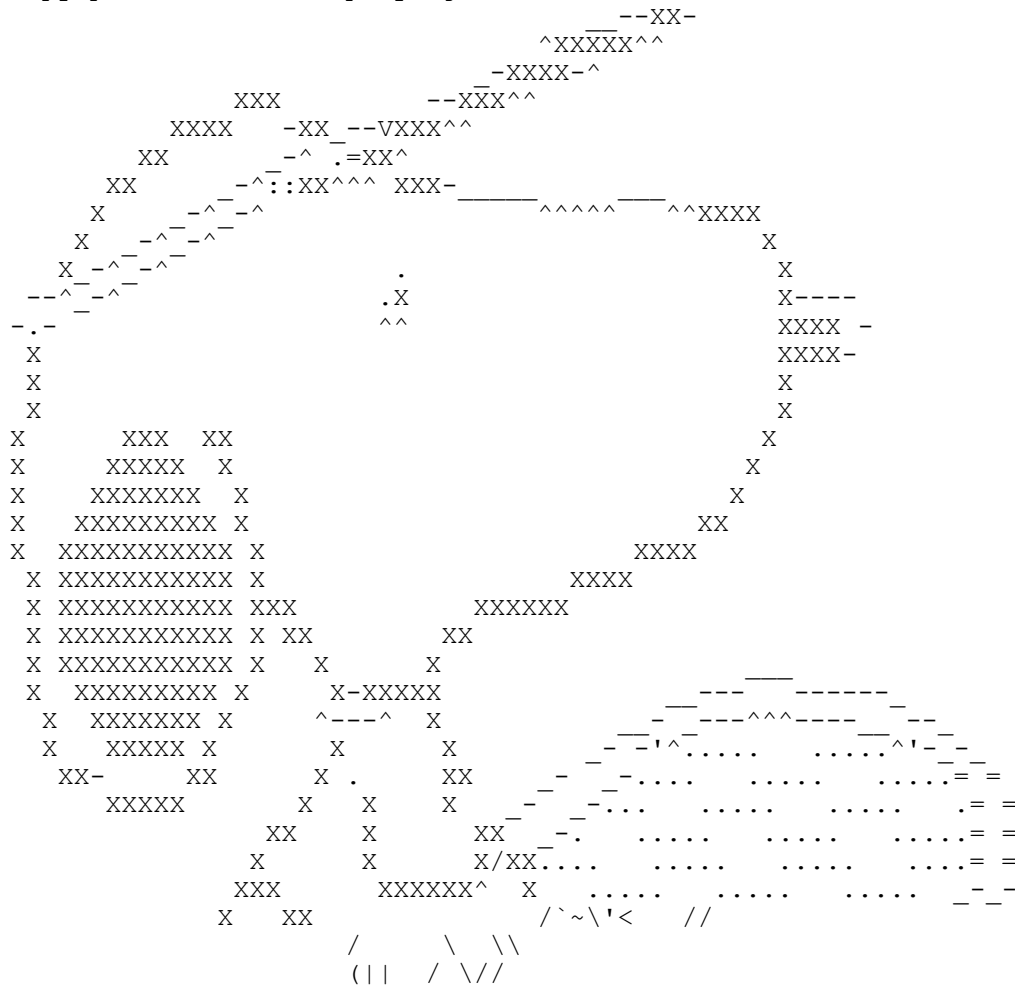











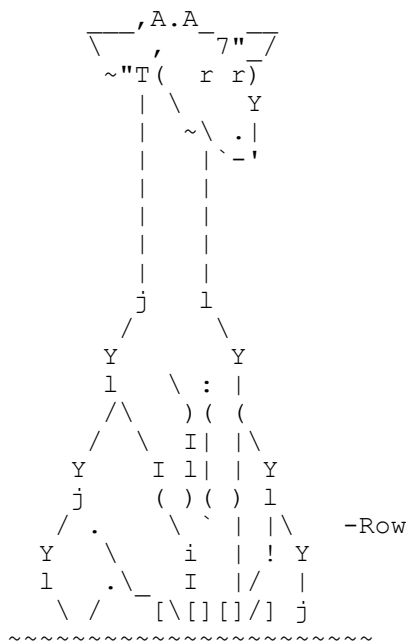
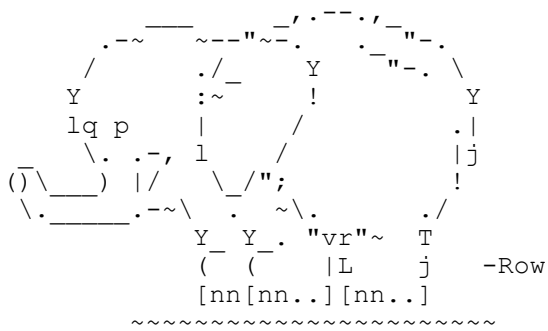
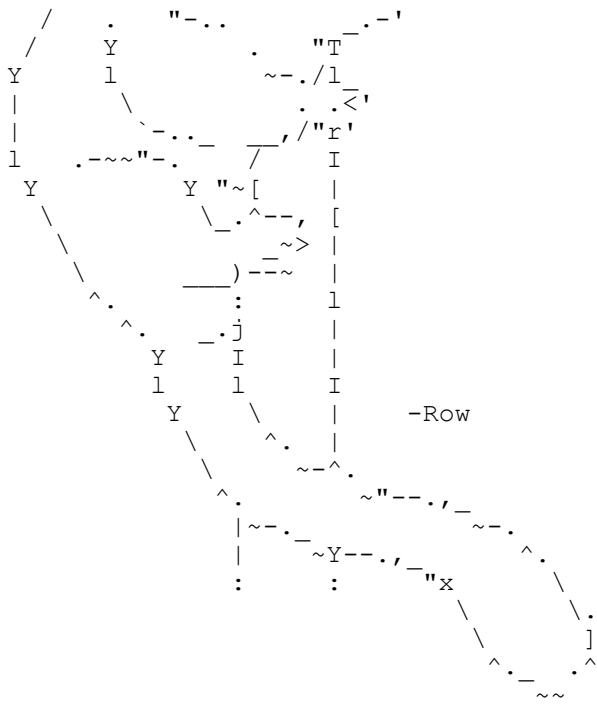

bd "n.



```

      :         ^         '         ,         :         /'~-----|
     _ \\\ \         ^         '         ,         :         /'~-----|
     ~~~~~         ^         '         ,         :         /'~-----|

```

From: silbern@u.washington.edu (Silberstein)

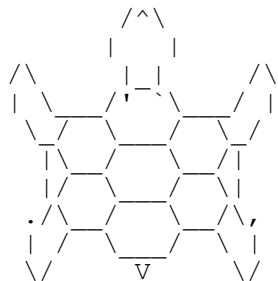

From: cthorpe@husc7.harvard.edu (Christopher Thorpe)

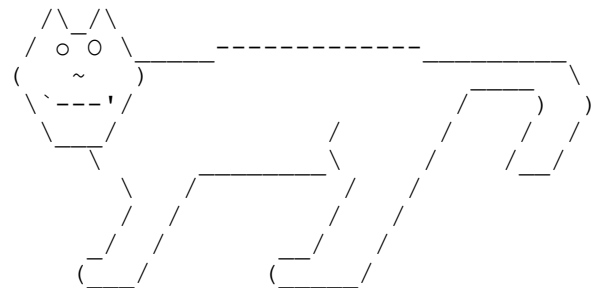

From: boba@gagme.wwa.com (The Scarecrow)  
[Kitten.]

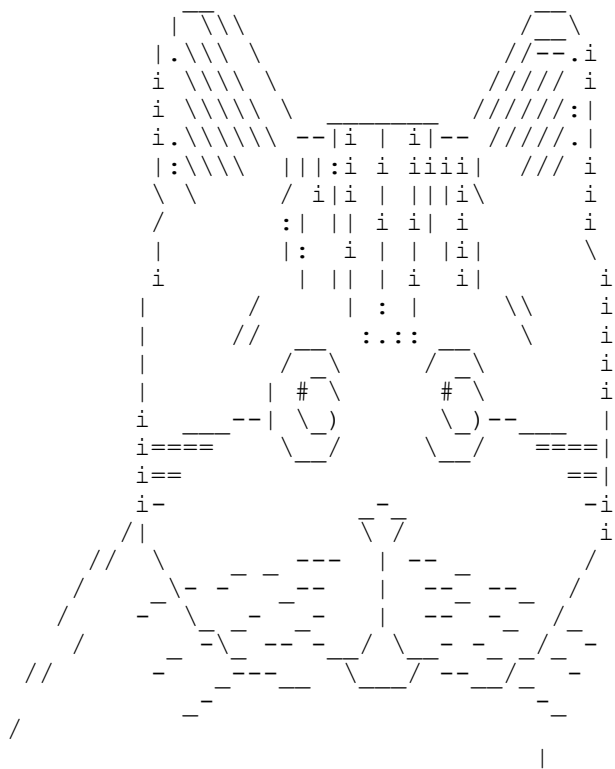



```

( / ( ( ^*+ +* ) < < \
U _/ ) ) *--< ) ^\-----++ ) ) )
( ( ) ( ^ ) ) ) \ ^ ^ ) ^*+ / / )
( / ( ) ( ^ ) ) ) ^ ^ ) ^ ^ ) + ^ ^
( _/ ( ) ( ^ ) ) ) ^ ^ ) ^ ^ )
*+ +* ( ) ^ ) ) ^ ^ ) ^ ^ ) * ^
\ _+ ( ) ^ ) ) ^ ^ ) ^ ^ )
( _ ^ \ _ ^ \ _ ^ \ _ ^ \ _ ^ \
^ ^ ^ \ uuu / ^ ^ \ uuu / ^ ^ \
) > ) > ^ \ \ \ \ \ \ \ \ \
^ ^ / \ \ \ ^ ^ / \ \ \ ^
^ ^ ^ ^ ^ ^ ^ ^

```

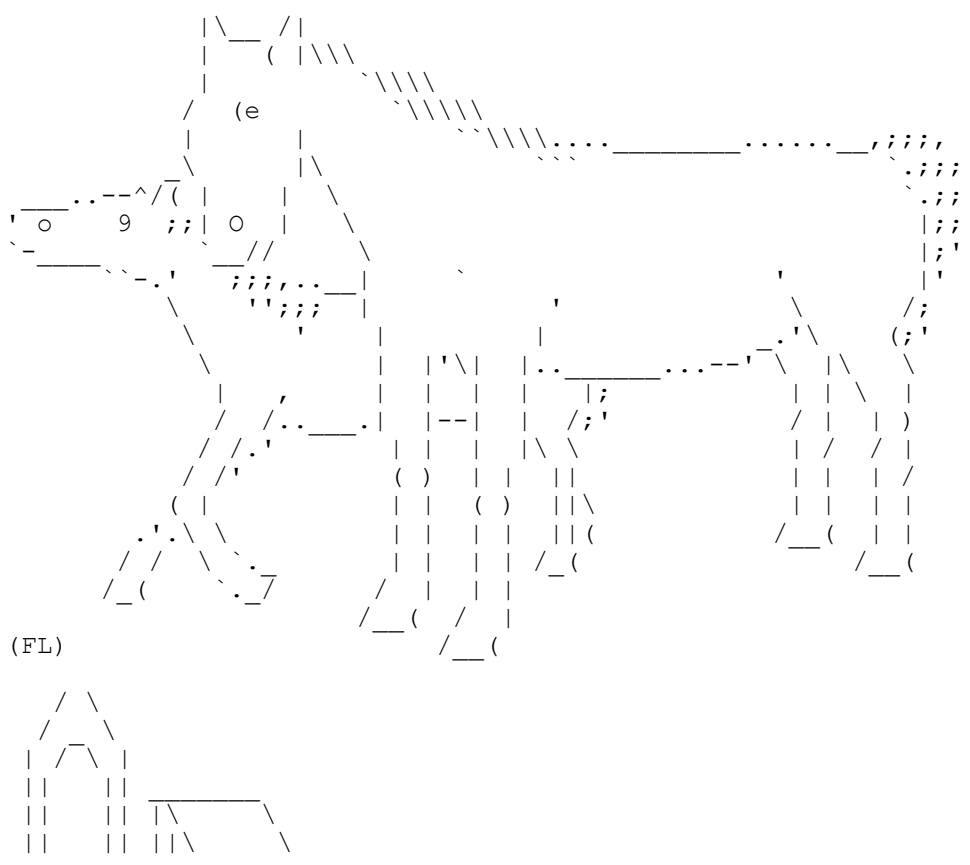
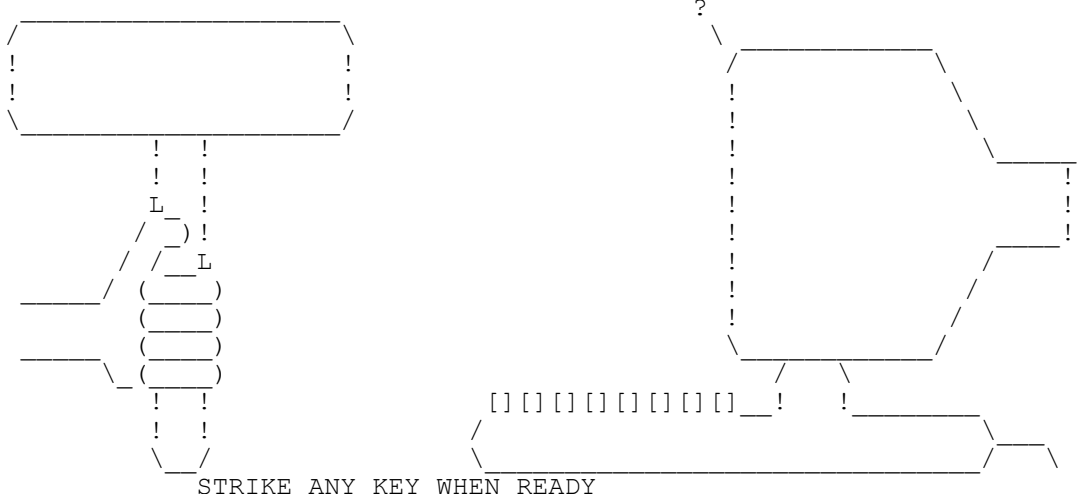







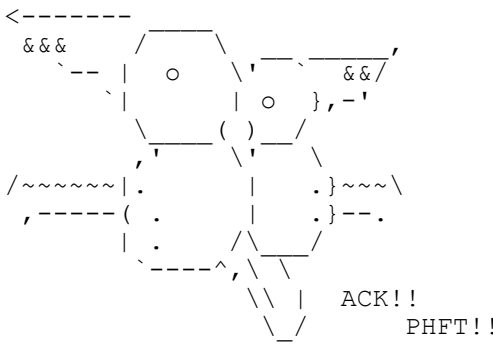
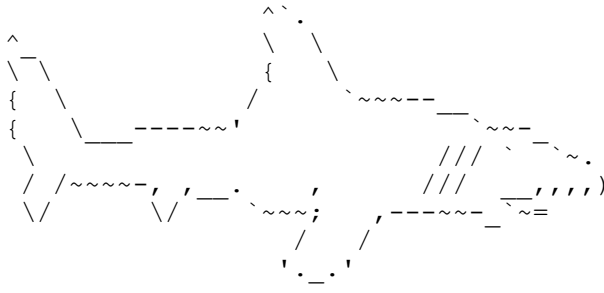
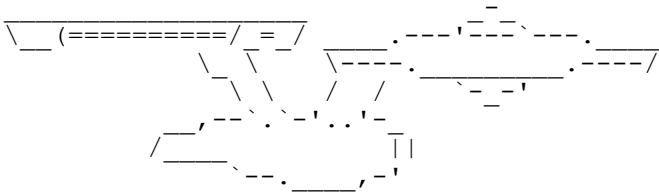
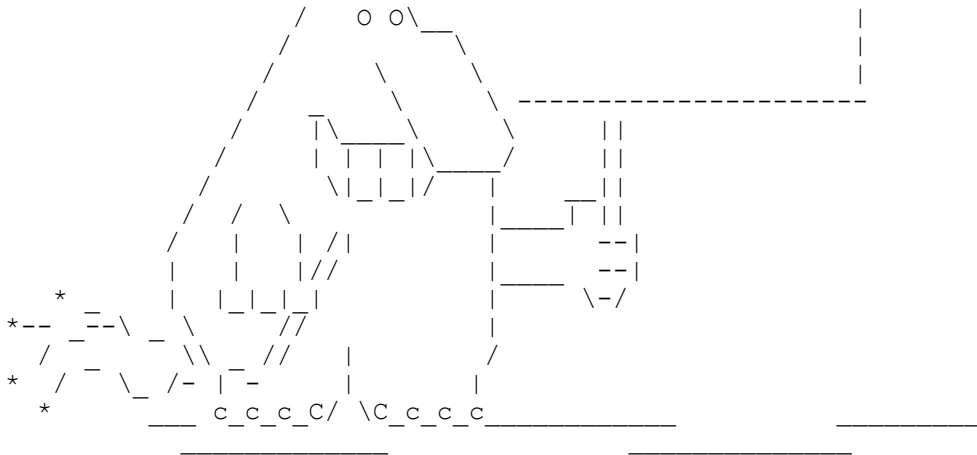

```

,d8b
,aP88b, P" "8.
,8" "bb88db, lb
dl " "b, .B'
"b. "b ,9'
"b "b
.J) "b.
.d "8a.

```

```

8          ,d' '9
d8         "    "b
88         d    B
88         MP   P
88         'ba+
"8         YP
"8         d    P
ba_b,      "b."b, .d'
L;;PMMmbaa_ "d88ad8'
L.n;;;;;"Ymba."8.
,V;;;;;;;;;"Man,8b.
gd;;;;;;;;;"Mb;Mb.
gd;;;;;;;;;"Mb,
d8b;;;;;;;;;b;;;;;;;;;"b,
7P"8ba;;;;;B;;;;;;;;;"Na
8"      "8b;;a";;;;;;;;;lB.
B        "8b,d;;paaaaaaqaL;;"B
,B        P" """" "Y8bmdMb
dP        dP          "ba,
8          B'         "ba
8,         B          "ba_
"b         B          b8_
B          78         8^"8,
P          d"         "8 "8,
6.         aP         B, 6J
(8         .d, ,      ,      Bg. B'
"8bP"8.P    "ba.      .P 8P
'w8         "8ba.     B"
8.          8.        l8      .8"
"b.         8a        B'
d8'b.       B.       XP'
d"         "ba.      P XP
.8         "ba_      ad8ba
l8         'Bb,      aP" "8.
'8         .adP""9a .d" d_ lb
l          .ad"      "ad" f" lP
8          ' "b      88 l' ;l"
8a         'l       ll l  lB
8b         lb      "8.'l. "P
'9         P'      lb.' 8"
'98P       8ba_aP"
            ,""",

```

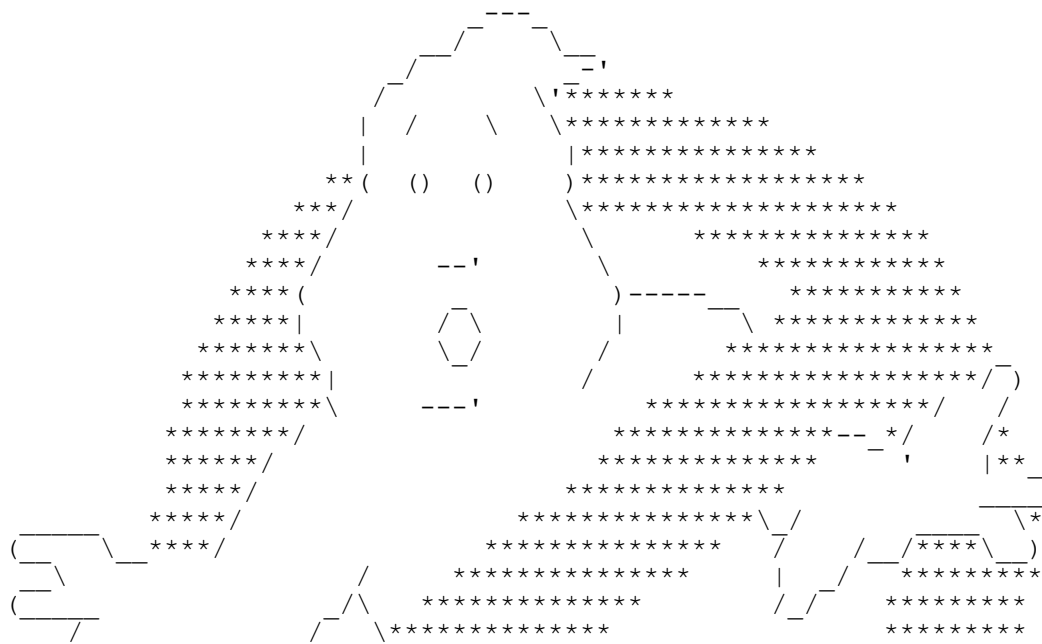

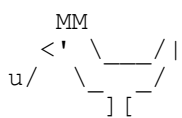
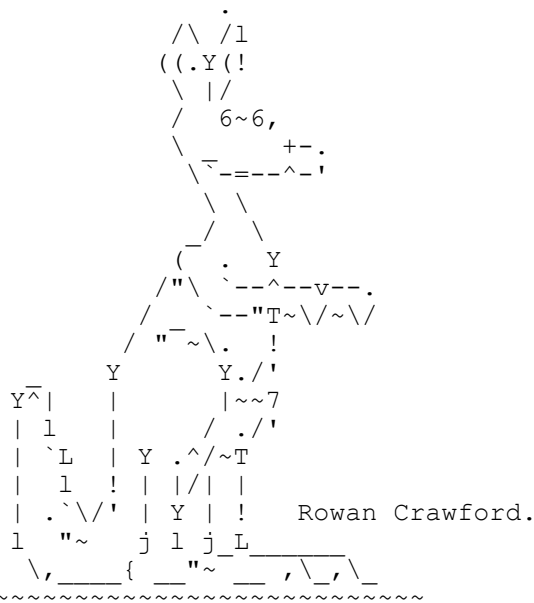
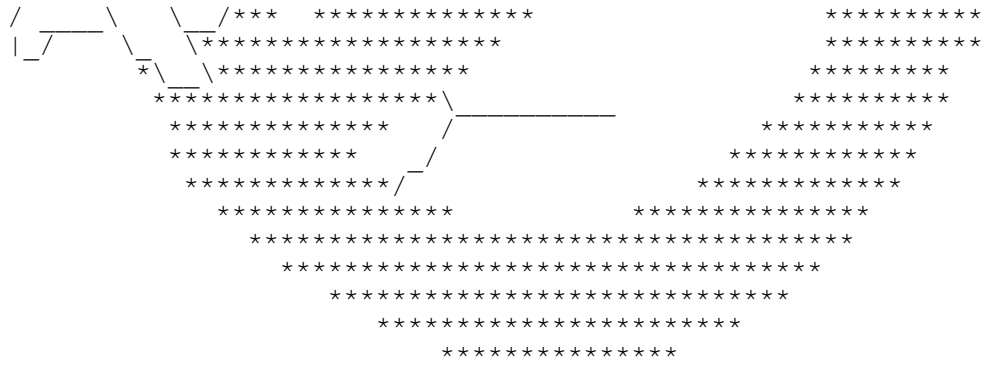

Chicken Smoking  
a Pipe

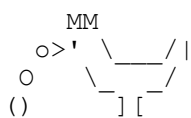

Puking Chicken

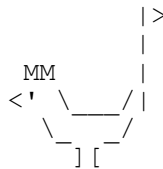

Chicken Leading a  
Japanese Tourist Group

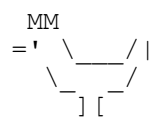

Whistling  
Chicken

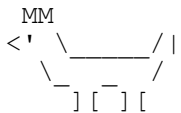

Four-Legged  
Chicken

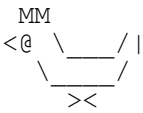

Stoned Chicken

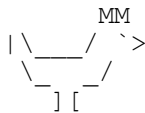

Chicken Looking in  
the other Direction

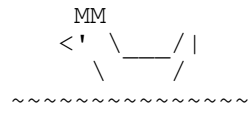

Chicken that Thinks  
it is a Duck



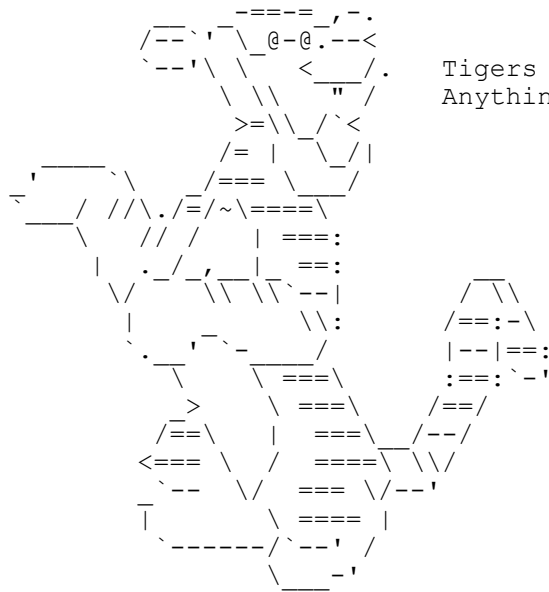
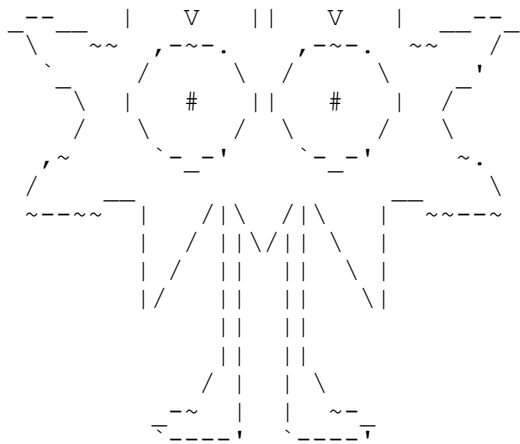

Tigers can do  
Anything!

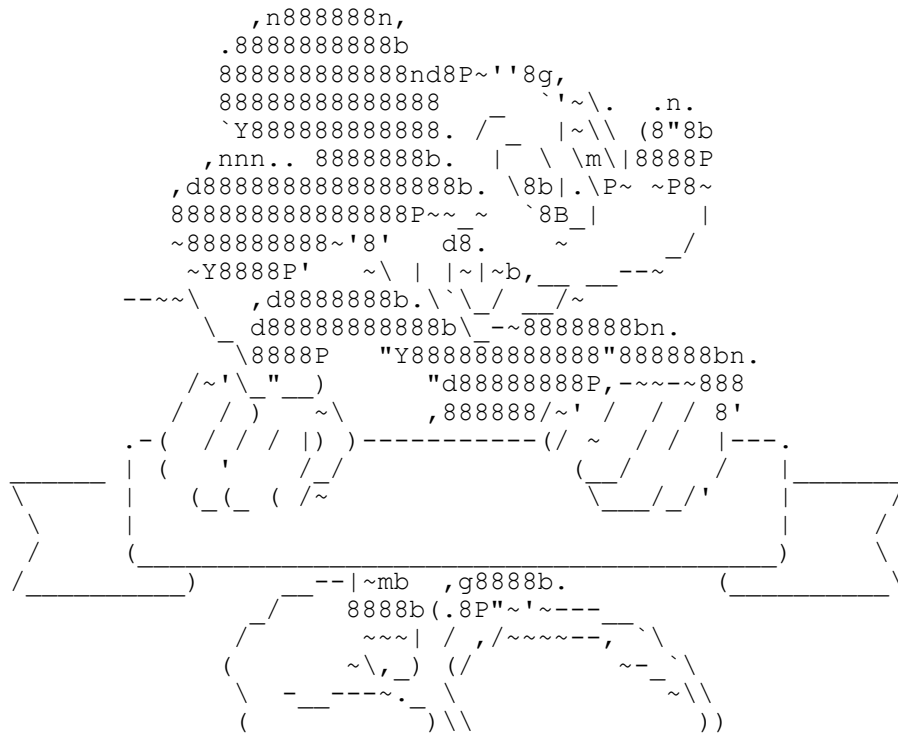

```
\ \_ ~~~ " - ~~~ \ |
  \_ ~~~ " - ~~~ \ |
```

```
/mmm\  
(O o)  
  U  
||\  \\  
oOOo_oOOo
```

(Bad answer)

```
/mmm\  
(O O)  
  U  
 /  \\  
   oOOo
```

(Retry)

```
/mmm\  
(o o)  
  u  
  .  
_____
```

(Once more)

```
/mmm\  
(- -)  
  u_oOOo_____
```

(Bored & Asleep)

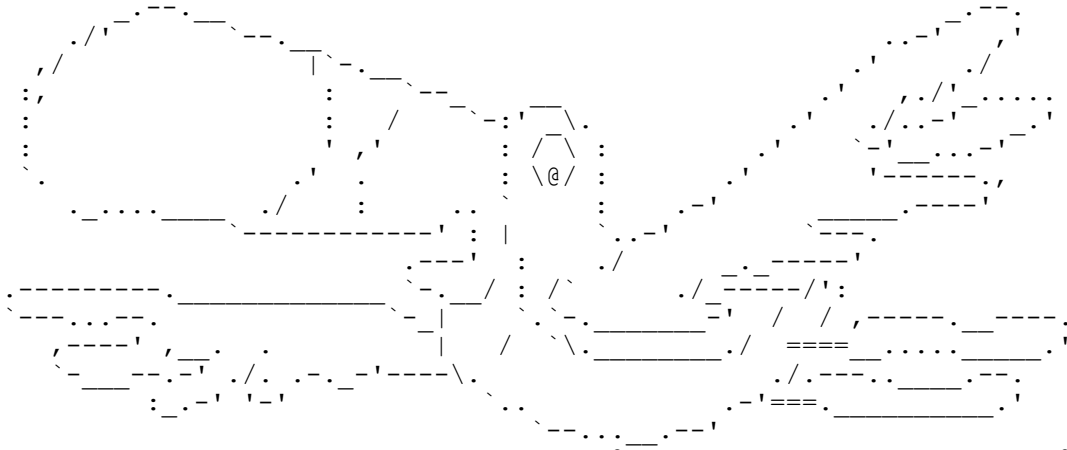
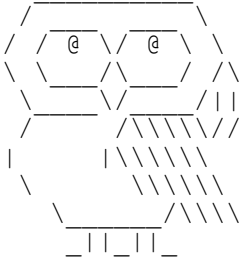

.8. 8 .o8P' `888' 8 .o8P' `8.  
.8P'8. 8.dP' `Y8 .o d| .d8' .o. `8  
8' Y 88P o b. oP' 8' .8' .dP`8 8.  
.o8 8. 88 Y .8' 8 .8'.o8P' 8.  
`88P'8 `8. 8 o8o..o88odP d 8 .8'.8' `8.  
.8' `Y888. d8 d' `8P `8. 8 8 .8'.8' `8..dP'  
`Yb 8`b .P Y `8 8 888 .8' `8P'  
8 8 `b 8 b .888o. .8 88 .8888888888o.  
d' d' `b. 8 8 P' `8 88 8 .8' `Y8o.  
.8 .P `8b. 8 P' 8.d88 8.8' `Y8o.  
.8' P `Y8888 88888 8888 88' .d8b. 8b  
8' 8 d8888P Y88oo88888o. 8 8 8  
8 .d 8 d8888P `8. `Y8P'  
Yb 8 o888 8 d888P' b. `8  
8 8 .d8888b d' d88P' .o b. `8 8  
d8 .o8b.o88888888b. .8 d888. .d8' `8. 8.d8  
.d888 .o8888888' d88888888o. .8' .d8888888888888 888Y88P' .o8P'  
8 888o. `888888888888' o8888888P`Y8888888P .o88P'  
8 8 `Y8o. `888888P .88888P' .o888b. .o88P'  
8 8 `Y8oo888. Y8888P o88P' .8' `888P'  
8 8 `8 `8. `Y88 o8P' .o88o. 8' 88  
8 8 8. `8. `b o88 8' .8 .8 8  
8 Yb `Y. .8Y8o. `8888 `Y88P'.o88P8. .dP .8o.  
8 `b Y88P `Y8o. .o88P' `Y888P' .P' 8  
8 `b `Y8o. .o88P' 8. .8  
8 8 `Yb. .o88P' `Y8P'  
8 .8 `Y8P'  
8 .oP' .o88o. .o888o 8  
8 8P .P' `8 dP' `b 8 .o8o. o8o.  
8 8 8. .d' d' 8 8 .o8o. .dP' `8 d' `8  
8 8 `Y88P' d' 8 8 dP 8 dP' 8 d' .8  
8 8 8 d' 8 d' 8 d' 8 d' .P'  
d| 8 `b. .d' 8 d' d' d' d' 8 .P  
8' 8 `8888P' 8 d' .d' 8 .d' Y88P d|  
8 .88o 8 8. dP' 8. .dP' .8'  
8 8 8 8 `Y8P `Y88P' .8'  
8 8 .o8888o. 8 .dP'  
.o88888 Y8P' 8' `8 8 .dP'  
o8888888 8 8 .d8b. .d8'  
88888888. 8. .d' .8' `8. .db. .d8P  
`Y8888888o. .o8o. `Y888P' .8' `8 .P' 8 .dP'  
`Y88888888888888o. .8' 8 8 8 .o8P'

```

`Y888888888888      8'      .8      8. d'      .dP'
  `Y8888888888      8      .8'      `YP'      .dP'
    `Y88888b.      8.      .8'      .o8P'
      `Y888b.      `Y888P8      .o8P'
        `Y88b.      8      .dP'
          `Y8b.      8      .o8P'
            `Y8o.      8      .o8P'
              `Yb.      8      .o8P'
                `Yb.      8      .dP'
                  `Y88888P'

```

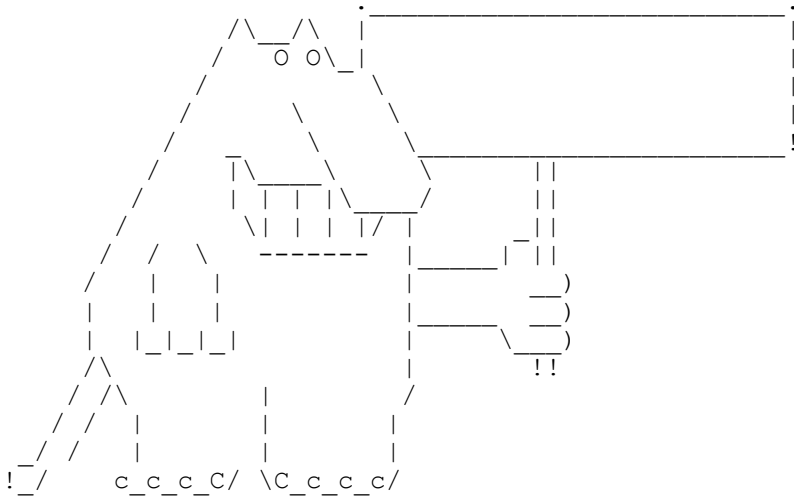

```

o8%8888,
o88%8888888.
8'- - -:8888b
8'      8888
d8.-=. ,==-.:888b
>8 `~` :`~' d8888
88      ,88888
88b. `~` ':88888
888b ~==~ .:88888
88888o--:'::8888
`88888| :::' 8888b
8888^^' 8888b
d888      ,%888b.
d88%      %%8--'-.
/88: .__ ,      %-' ---
      |__      -'---

```

Normal Mona

```

o8%8888,
o88%8888888.
8'- - -:8888b
8'      8888
d8.-=. ,==-.:888b
>8 `~` :`~'
88      ,88888
88b. `~` ':88888
888b v=v~ .:88888
88888o--:'

```

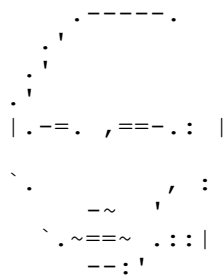



8888M::::888MM::::8::::M::::8888::::M::::M  
88888M::::88:M::::8::::M::::8888::::M::::M  
88 888MM::::888:M::::M::::8888::::M::::M  
8 88888M::::88:M::::\*88\*::::M:88::::M  
888888M::::88:M::::88@@88::::M:88::::M  
888888MM::::88:MM::::88@@88::::M::8::::\*8  
888888 M:::8:MM::::\*88\*::::M::::88@@  
88888 MM::::MM::::MM::::88@@  
888 M:::MM::::MM::::M:::MM::::\*8  
888 MM::::MMM::::MM::::MM::::M  
88 M::::MMMM::::MMMM::::MM  
88 MM::::MMMMMMMMMMMM::::MMMM::::MMMM  
88 MM::::MMMMMMMM::::MMMMMMMMMMMM  
88 8MM::::MMMMMMMM  
8 88MM::::M:M::::MM  
888MM::::MM::::MM::::MM  
88888MM::::MMM::::mM::::MM  
888888MM::::MMM::::MMM::M  
88888888MM::::MMM::::MM::M  
88 8888888M::::MMM::::M::M  
8 888888 M::::MM::::M::M:  
888888 M::::M::::M::MM  
888888 M::::M::::M:M  
888888 M::::M::::@::::M:M  
88888 M::::@@::::M:M  
88888 M::::@@@::::M::M  
88888 M::::@@::::M:M  
88888 M::::m::::@::::M::M  
88888 M::::M::::MMM::::M::M  
8888 MM::::Mm::::MMMM::::m:m::M  
888 M::::M::::MMM::::M:mm::M  
8888 MM::::MM::::mM::MM::M:  
M::::M::::mM::MM::Mm  
MM::::m::::M::MM::MM  
M::::M::::M:M::MM  
MM::::M::::M::::M::M::MM  
M::::M88::::M::::MM::MMM  
M::::888888888M::::MM::MM  
M::::88888888M::::M::MM  
M::::888888M::::M::MM  
M::::88888M::::M:MM  
M::::88M::::MMM  
M::::M::::MMM  
MM::::M::::MMM  
M::::M::::MMM  
MM::::M::::MMM  
M::::M::::MMM  
MM::::M::::MMM  
M::::M::::MMM  
MM::::M::::MMM  
MM::::M::::MMM  
MM::::M::::MMM  
MM::M::::MMM  
MM:M::::MMM  
MMM::::MMM  
MM::::MMM  
M::::MMM  
MM::::MMM





```

: . . . . . V: . . . . . I: ' . HV:
: . . . . . II: . . . . . ' : ' AV.'
: . . . . . VI: . . . . . : . AV'.
' : . . . . . HAI: . . . . . AII: .
I: . . . . . VHHII: . . . . . A: ' . . .
IA. . . . . VHHHHIHIIHHIHI: ' . . .
'HA: . . . . . HHHIHIIHHIHI: . . .

```

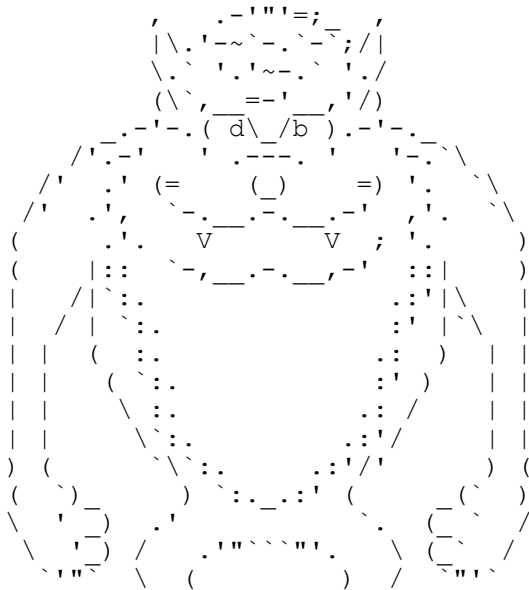
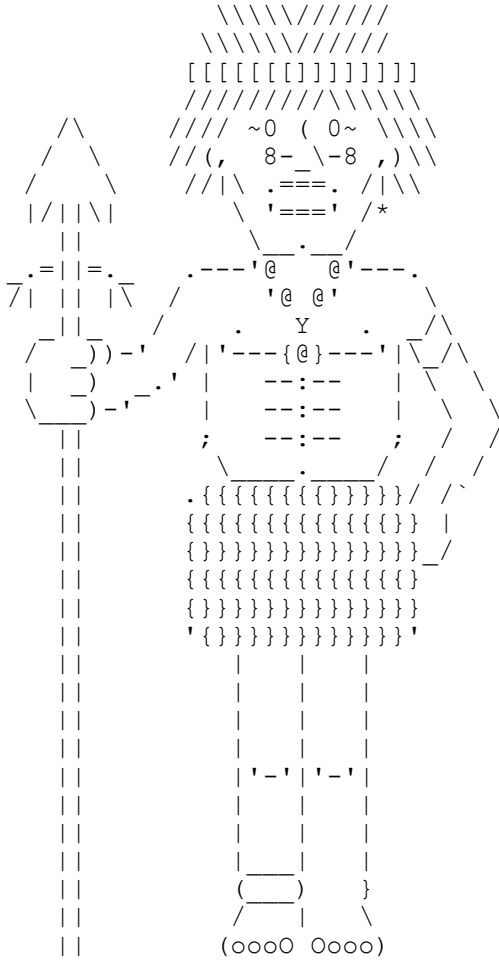



une petite danse

```
O/\o
/Y X\
\\/<
```

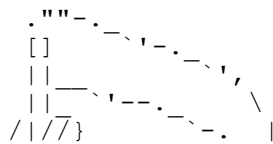
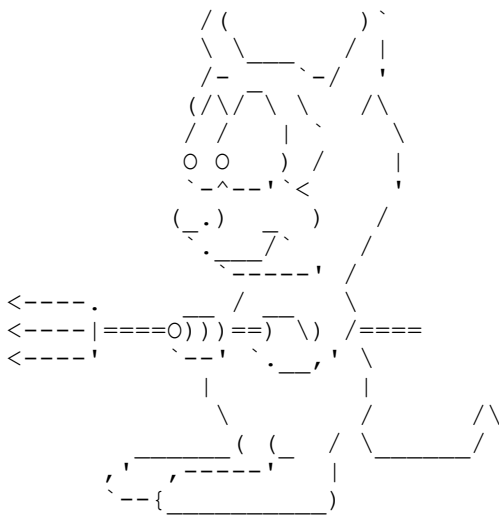
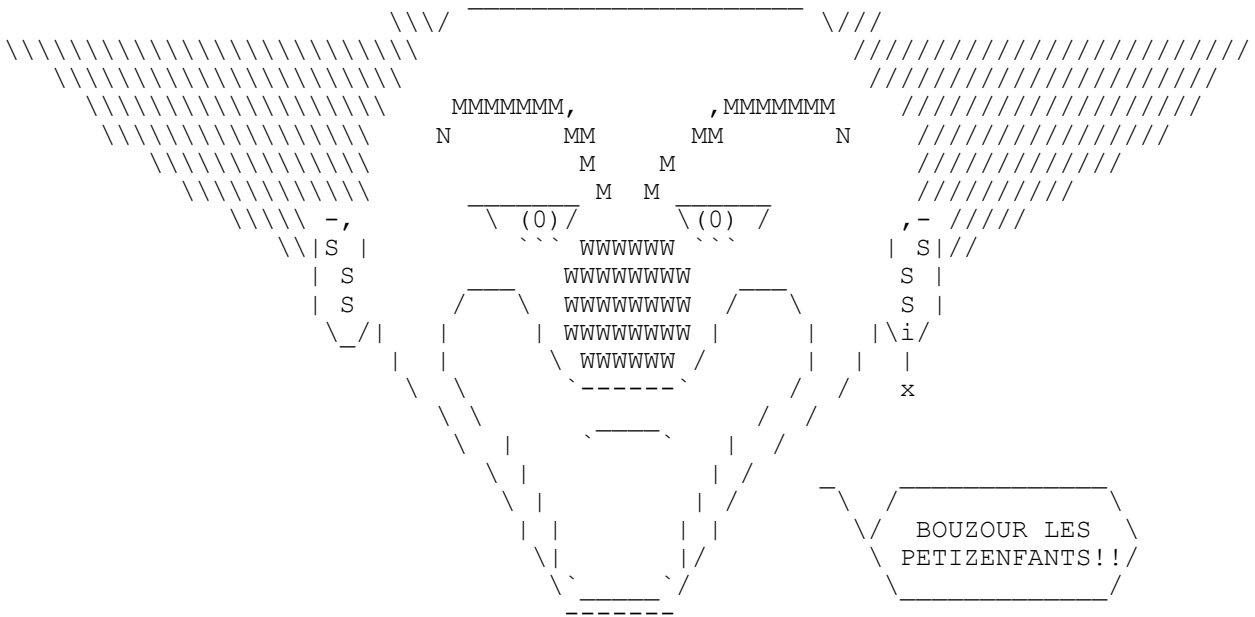

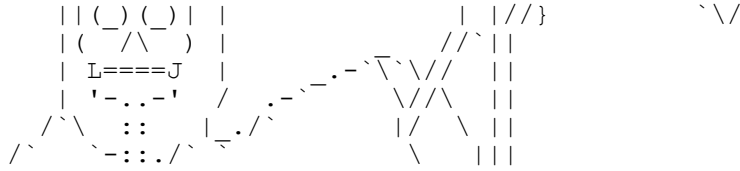

ASCII Art by Joan Stark  
<http://www.geocities.com/SoHo/7373/>

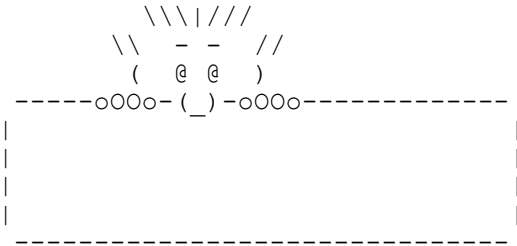
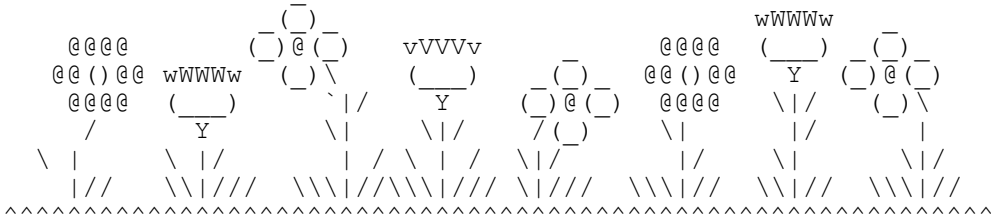
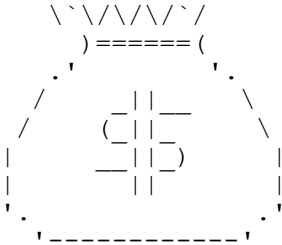
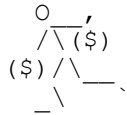
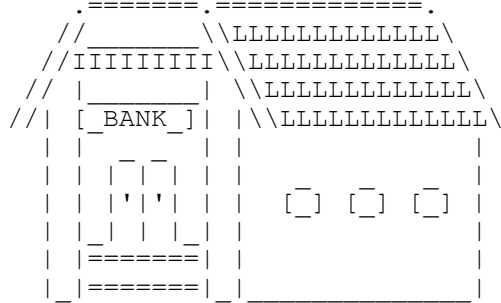

```
uJ$$$$$$',J <$Sh.      .,J+.
 ,J$$$$$$z$F,J$$??$Sh- =<$C$$$>-.zJ"J?? $$ccc,.
.r$$$$$$$$$$$$$$$$F "$$$hJ$$$$$'zJ$$$P" ,z$$P$F$hu
J$h?$$$$$$$$$$$$$$$$$. ``$$$$$$$$$$$$"" ,J$xxx<$L$N
.P$$$$F"" " ' `"?$$Sh?$$$ucd$$$$$$$$$hcr$P"J?$$P""?Lc$F
J$JF          `?$C`$$$$$$$$"$$$$$$P",JP"     `$$$$F
?$F           `?h..`?$$$$$F" .,zP           $$$F
cc           u ..          $$P   `""""   J$$"   -c    "   $$$F
?F           , $ z$$$ ,ccu.,. `?$h          ,J$'.    $    .    ,$$F
;h           ?????$$$$$$$$$u   "h. p"   u$" JF      =    " ;;PP"
`?          <$hcr. `""????$r   `;d"   , $" `      JP"
```

```
$r      $$$$$$$$$$hccccc ,P",,,P" J$$$.P"
?      "?????????" ,p" "" J$$P" >'
      hcc,,. ==="F " uF
      `?$$$$-$h j' ..,J$$$.'"
      \. ""?h.`$$C " z$$P" $$"
      . ."????????" ,cL.,.,.,cc,h
      "$h,`$$$$F ?$C `$$$$$$$$"<$
      "?hu`"?$$F $$h. `???" .. ?
      "?hu ccccccccd$$$$$$$
      "?h."$$$$$$$$$???"
      `?hu` zcccccccd$$$$$$u
      `h,"$$$$$$$$$???"
      `?h.' .;cccd$$$$$c
      "$h."$$$$$$$$$$$$c
      "$h.?$$$$?????"
      .,zccccccccccu. `?su ,cc$$$$$$$$$c
      ,cc$$P",cd$$$$$$$$$$$$P""".zc$$$,?h $$$$$$$$$$.
      ,J$$$$P",cd$$$$$$$$$??"..,ccd$$$$$$$$$ $h`""""""",,,,,,
h ;J$$$$P",c$$$$$?"",ccc$$$$$$$$$$$$$$$$$$$$ $$$$ $$$$$$$$$$$$
`$ x$$?"",d$$$$?"",cd$$$$$$$$$$$$$$$$$$$$P". . ;$$',$$$$$$$$$$$$F;;
?h.__,zc$$$?"",cd$$$$$$$$$$$$$$$$$$$$P" zc<$$'F',J$$F,cccccccccc J$$su
`"????",zc$$$$$$$$$$$$$$$$$$$$P";Jr" ",uccd$$F J$$$$$$$$P J$$$$$h
`$$$$$$$$$$$$$$$$$??"",zc $$F .uJ$$$$$$$$P'..""""""""""",$$$$$$$
"?$$$$$??"",cr$$$?"",c$$$$$$$$$$$$P" <$$$$$$$$$,J$$$$P"
`"?? ??" `"?$$$$$$$$$,ccc,.`"???".,c,""?CLz>
      "??""! J$$$$$$$$$ " ??????????"
```

>chirp!<

>chirp!

>chirp!<

>chirp!<

>Cccrack!<

>chirp!<

>chirp!<

>chirp!<

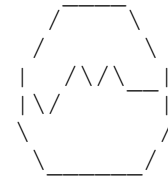
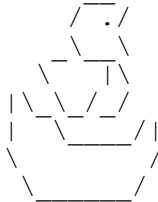
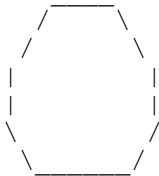

```
/""""""
| (.). )
C | ) \\\///
  | | /
< _Y> \\\///
  | | # \
/ | | # |
| | | # |
\\ | | # |
  \\ | =LI
  /// |
  | |
  | |
  | |
  | |
```

```
>-----<
|          |
| VISIT... |
| JOAN STARK'S |
| ASCII ART |
| GALLERY    |
|          |
>=====
```

```
,((((((,
((/))))))
) (.) (((((
(( _ ?))))
\\/_ ))|= /(((
  \ / (((\ ())))
  \_ ))//^(((
  \ | |
  \ | |
  \ | |
  // // \
  \\ \ /
  | |
  | |
```

joan stark <spunk1111@juno.com

<<http://www.geocities.com/SoHo/7373/>

jgs [ ] ( ) ( / / - \ )  
(( / / - \ ) / Y )

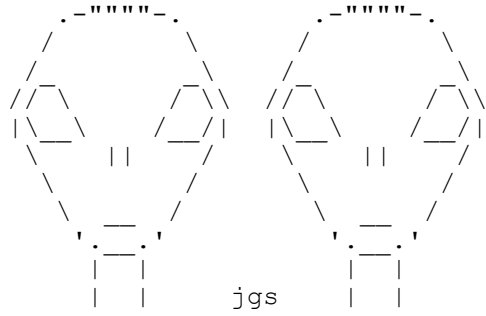
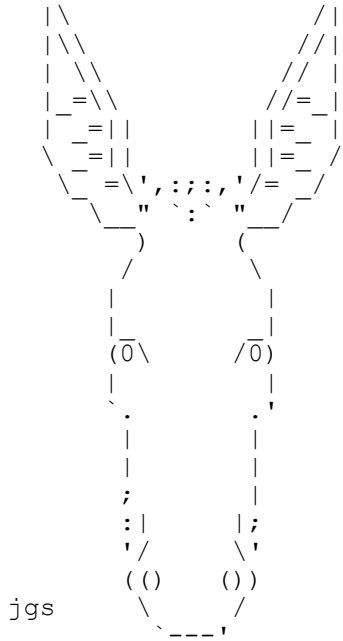

~  
~  
U  
U---; |  
+---U ==| |  
| : ^) U ==| |  
.---'---U | |  
| U |  
|) ( ) 'U |=====  
[ / , - , \ " - - - - // , - , , - , \ \ \ \ | / // , - , , - , , - , \ \ - = ]  
( 0 ) ==### // ( 0 ) ( 0 ) ' ' - o ' ( 0 ) ( 0 ) ( 0 ) ' ' ]

















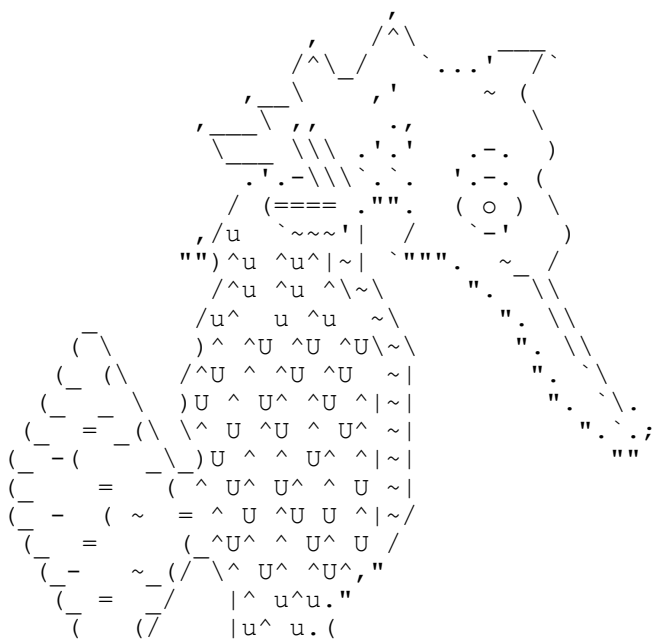
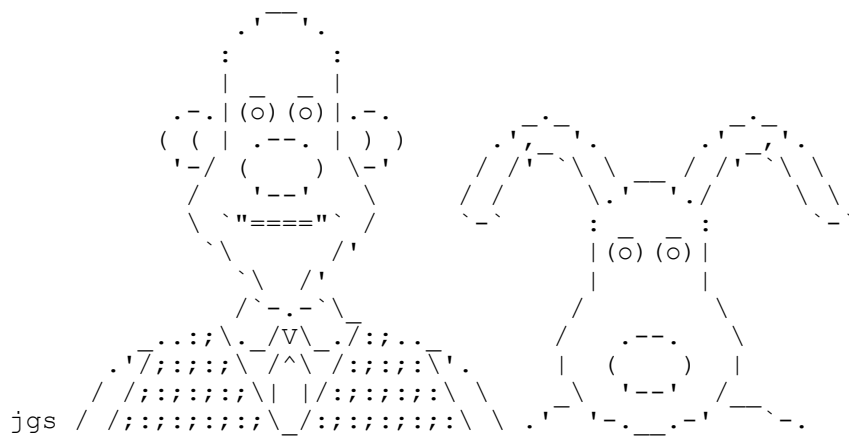
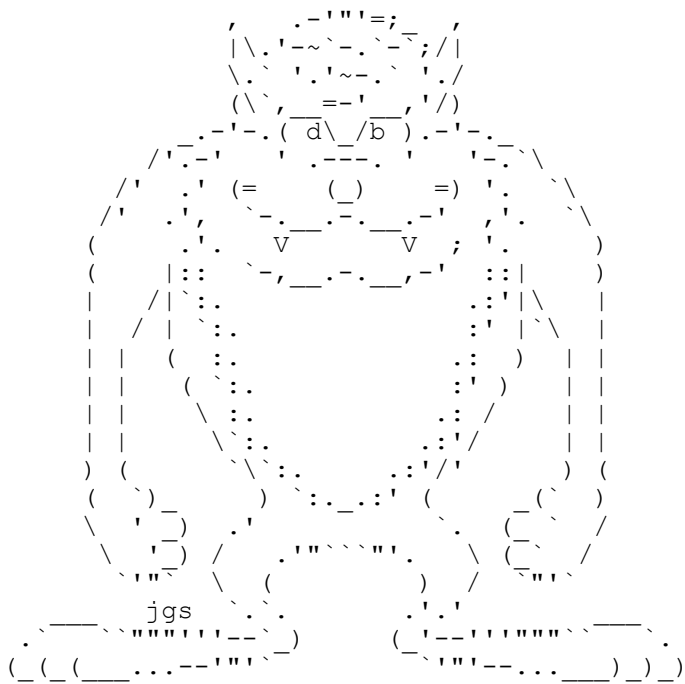





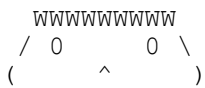
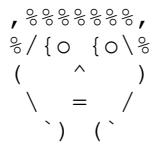
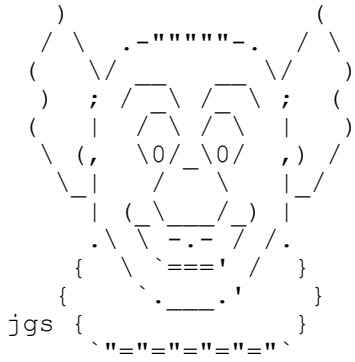
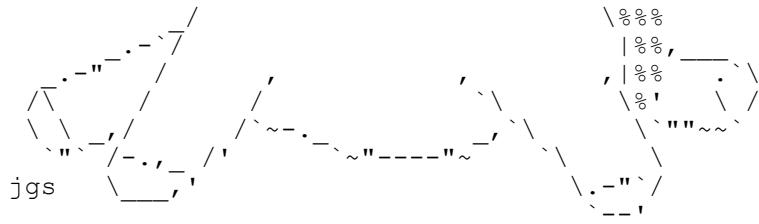









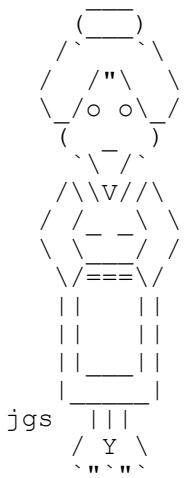
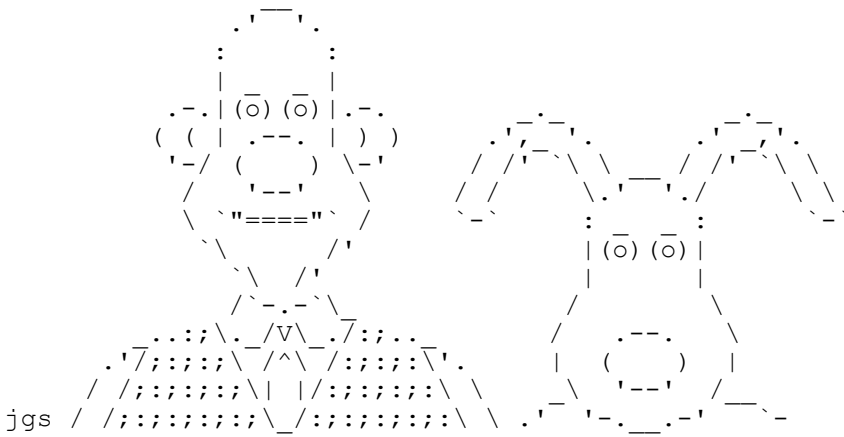
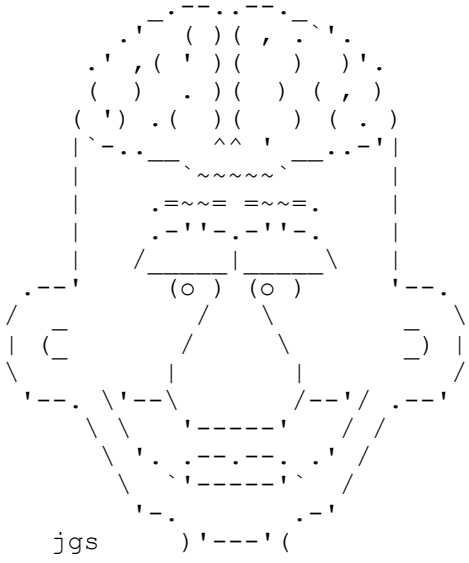
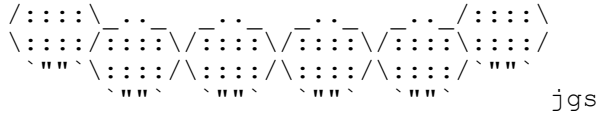

| \\_ / |



```

      /|\ / / ^ \ \ /|\
       / \ (   ) \ / \
      /  |   | \ /  |
     /___|___|\ /___|___\
    jgs
  
```

```

      .-.
     (  )
    /____\ /____\
   /_____\ /_____\
  /_____\ /_____\
 /_____\ /_____\
/_____\ /_____\
jgs
  
```

```

      )
     (/
    /  \
   /    \
  /      \
 /        \
/          \
jgs
  
```

```

      .-""-.
     (  / \ \
      ( | ^ ^ )
       ) \ = / (
      /  \ \ \ \ \
     /    \ \ \ \ \
    /      \ \ \ \ \
   /        \ \ \ \ \
  /          \ \ \ \ \
 /            \ \ \ \ \
jgs
  
```

```

      /:\
     =>:<=
     =>:<=
     =>:<=
     /:\
    #####
   // // // // //
  // / \ / \ \ \ \
 \ ( 0 0 ) /
  /\ \ = \ = / \ \
 \ \ \ \ --- / \ \ \
 // \ '----' // \
 \ \ / \ \ / \ \
 \ \ / \ \ / \ \
 \ \ / \ \ / \ \
  
```

jgs # #  
"

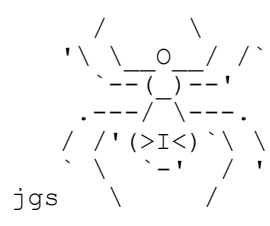
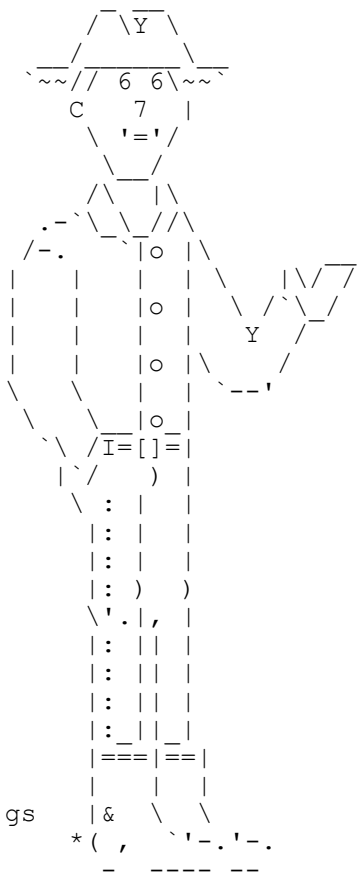
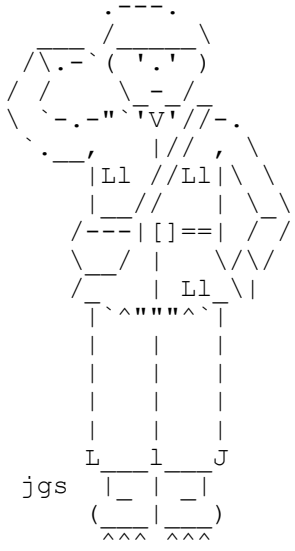



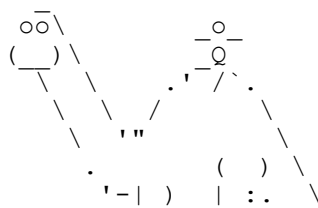
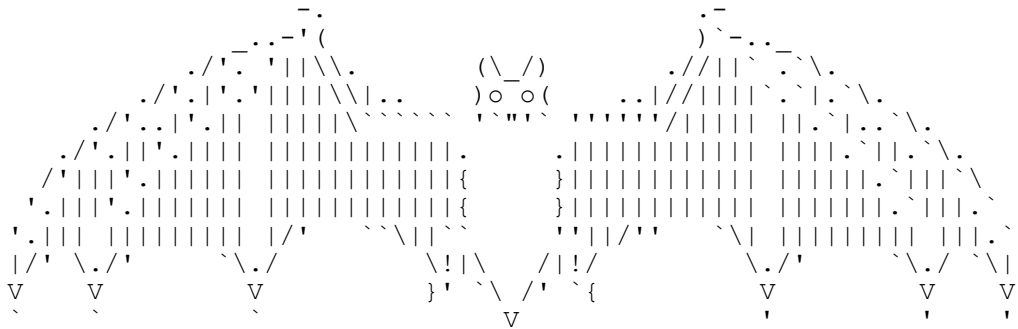
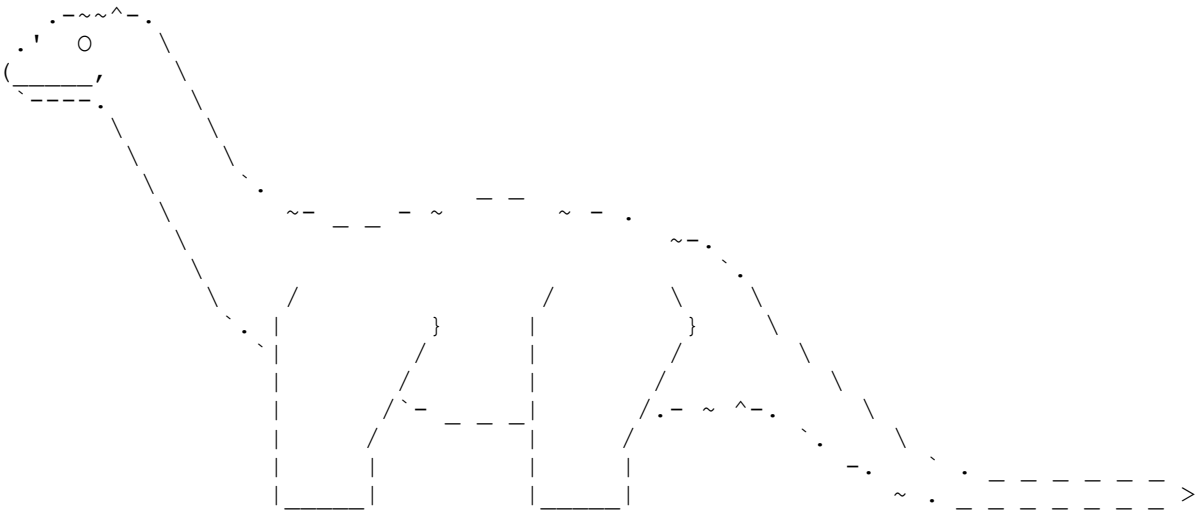
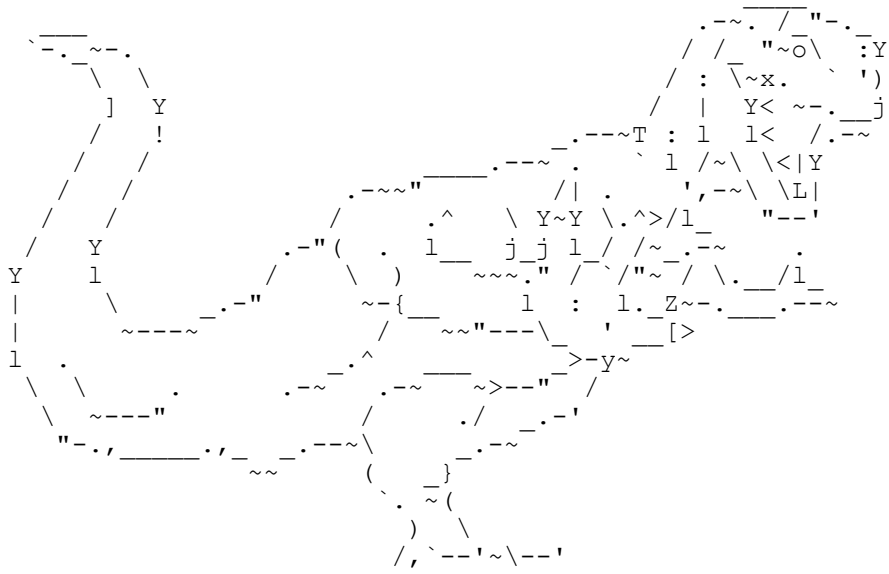

c \_; c \_; '...'>.\_

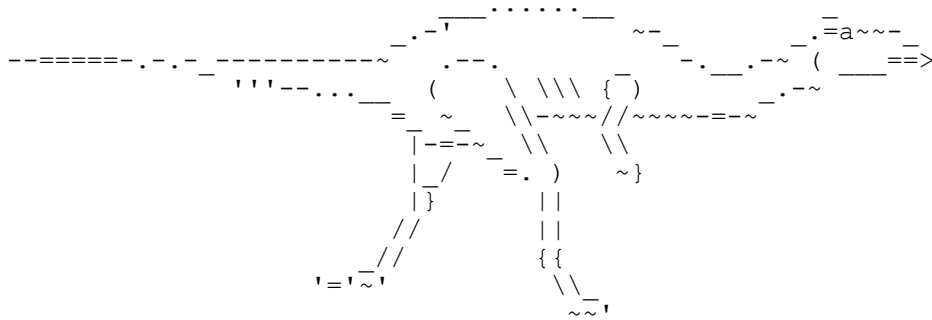

From: ferch@ucs.ubc.ca (Les Ferch)

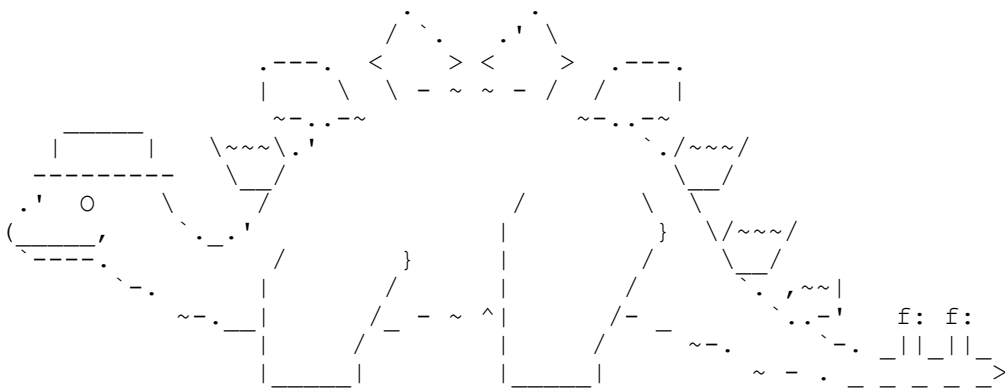
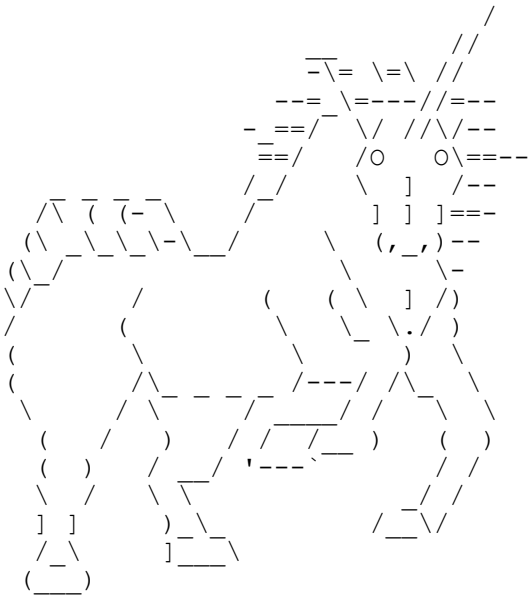







```

;tIVtVRYi:
:VMYttttttt=++,
YWMI,t ;,,,;iI=          LIU KANG WINS!
:YBRV+i +=,,
+VRXYi;
IRVVV:,,
tBXVXXI;:=
XBxitVVXY;,,
IMBVIYXVYXXVY=          YtiIi
i=:,=MiIXBMWY=          XWWWRR,
      Yt,,,;tVBMWV      IRWWWWWMM=,
      ;tRWWt      :XBWWWWWV,
      ;I          =tRMM      =XBttRBMwi,
,=++++=:X          ;YBMM      Yt,iIIRB,
==,, ,=ti          : :iXMMB      :,,,iVVi,
=;;          =+ttiIiitIIMWt      ,,,,I+,
=i;.          ;iIYYVI+tBMRBMMI      .....:,
:IVI;::;+tY++VXVXRY:=iIi:      ;:.....;
,iYVVYIt=,,VXIti+=,,:,,,,,      ;:.....=
      iV,,,,,,,,,:::it+=,..+;,,,..t.  Greg C. Smith

```

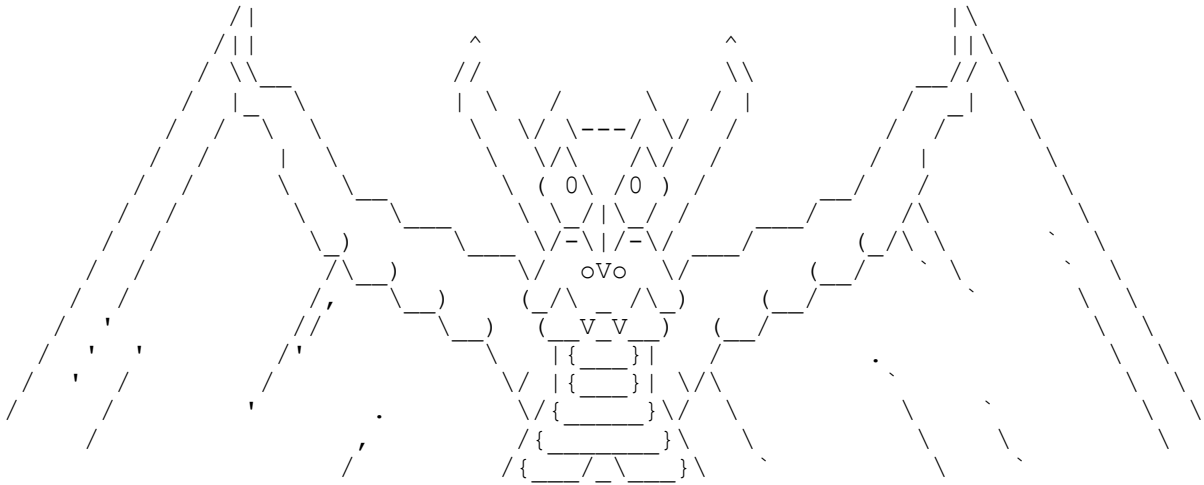

Adrian Elhart



```

<xeee..
ueeeeu..^"*$e.
ur d$$$$$$$$$$$$$$$$Nu "*"Nu
d$$$ "$$$$$$$$$$$$$$$$$e."$c
u$$c "" ^^^*$$$$$$$$$$$$$$$$b.^R:
z$$#" "" `!$$$$$$$$$$$$$$$$N.^
.$P ~!R$$$$$$$$$$$$$$$$b
x$F **$b. "R).$$$$$$$$$$$$
J^" #$$$$$$$$$$$$$.
z$e .. **$$$$$$$$$$$$

```

```
:$P . .$$$$b. . " #$$$
$$ L ^*$$$$b " 4$$$$L
4$$ ^u .e$$$$e."*$$$N. @$$$$
$$E d$$$$$$$$$$$$$$$$L "$$$$ mu $$$$$F
$$& $$$$$$$$$$$$$$$$N "#* * ?$$$$$N
$$F '$$$$$$$$$$$$$$$$$bec...z$ $$$$$$
'$$F `$$$$$$$$$$$$$$$$$$$$$$$$ '$$$$E"$
$$ ^"$$$$" ^"*$$$& 9$$$$N
k u$ "$$. "$P r
4$$$$L "$. eeR
$$$$$k '$e. .@
3$$$$$b '$$$$
$$$$$ 3$$"
$$$$$ dc 4F
RF**
```